

**Part number:**

**49001-0401**

**Copyright**

© 2012, FLIR Systems, Inc.

All rights reserved worldwide. Names and marks appearing herein are either registered trademarks or trademarks of FLIR Systems and/or its subsidiaries. All other trademarks, trade names or company names referenced herein are used for identification only and are the property of their respective owners.

March 13, 2012, 09:20 AM

**Corporate Headquarters**

FLIR Systems, Inc.  
27700 SW Parkway Ave.  
Wilsonville, OR 97070  
USA  
Telephone: +1-503-498-3547

**Website**

<http://www.flir.com>

**Customer support**

<http://support.flir.com>

**Legal disclaimer**

Specifications subject to change without further notice. Camera models and accessories subject to regional market considerations. License procedures may apply.

Information and equipment described herein may require US Government authorization for export purposes. Diversion contrary to US law is prohibited.



**General description**

The E-Series' model FLIR E50 offers an outstanding solution for professional thermographers conducting electrical and mechanical inspections.

**Key features:**

- Digital camera, 3.1 Mpixel
- Laser pointer
- Picture-in-Picture (scalable)
- Thermal Fusion (interval, above/below)
- Voice (via Bluetooth)/Text annotation
- Delta T – Difference Temperature
- Zoom 4x
- 6 color palettes
- Wireless communication
- MeterLink connection
- External window correction
- FLIR Tools software

Unmatched quality, outstanding ease of use, excellent ergonomics, lightweight and small!

**Imaging and optical data**

IR resolution	240 × 180 pixels
Thermal sensitivity/NETD	< 0.05°C @ +30°C (+86°F) / 50 mK
Field of view (FOV)	25° × 19°
Minimum focus distance	0.4 m (1.31 ft.)
Focal length	18 mm (0.7 in.)
Spatial resolution (IFOV)	1.82 mrad
F-number	1.3
Image frequency	60 Hz
Focus	Manual
Digital zoom	1–4x continuous
Panning	Panning over zoomed-in images

**Detector data**

Detector type	Focal plane array (FPA), uncooled microbolometer
Spectral range	7.5–13 μm

**Image presentation**

Display	Touch screen, 3.5 in. LCD, 320 × 240 pixels
Image adjustment	Auto or manual

**Image presentation modes**

Image modes IR image, visual image, thermal fusion, picture in picture,



# FLIR E50 (incl. Wi-Fi)

P/N: 49001-0401

© 2012, FLIR Systems, Inc.  
All rights reserved worldwide.

## Image presentation modes

Thermal fusion	IR image shown above, below or within temp interval on visual image
Picture in Picture	Scalable IR area on visual image

## Measurement

Object temperature range	-20°C to +120°C (-4°F to +248°F) 0°C to +650°C (+32°F to +1202°F)
Accuracy	±2°C (±3.6°F) or ±2% of reading

## Measurement analysis

Spotmeter	3
Area	3 boxes with max./min./average
Automatic hot/cold detection	Auto hot or cold spotmeter markers within area
Isotherm	Detect high/low temperature/interval
Difference temperature	Delta temperature between measurement functions or reference temperature
Reference temperature	Manually set or captured from any measurement function
Emissivity correction	Variable from 0.01 to 1.0 or selected from materials list
External optics/windows correction	Automatic, based on inputs of optics/window transmission and temperature
Measurement corrections	Reflected temperature, optics transmission and atmospheric transmission

## Set-up

Color palettes	Arctic, Gray, Iron, Lava, Rainbow and Rainbow HC
Set-up commands	Local adaptation of units, language, date and time formats

## Storage of images

Image storage	Standard JPEG, including measurement data, on memory card
Image storage mode	IR/visual images; simultaneous storage of IR and visual images

## Image annotations

Voice	60 seconds (via Bluetooth)
Text	Text from predefined list or soft keyboard on touch screen
Meterlink	Wireless connection (Bluetooth®) to: Extech Moisture Meter MO297 Extech Clamp Meter EX845
Report generation	• Separate PC software with extensive report generation

## Video recording in camera

Non-radiometric IR-video recording	MPEG-4 to memory card
------------------------------------	-----------------------

## Video streaming

Radiometric IR-video streaming	Full dynamic to PC using USB
Non-radiometric IR-video streaming	Uncompressed colorized video using USB

## Digital camera

Built-in digital camera	3.1 Mpixel (2048 × 1536 pixels), and one LED light
Digital camera, focus	Fixed focus
Built-in digital lens data	FOV 53° × 41°
Digital camera, aspect ratio	4:3

## Laser pointer



# FLIR E50 (incl. Wi-Fi)

P/N: 49001-0401

© 2012, FLIR Systems, Inc.  
All rights reserved worldwide.

## Laser pointer

Laser classification	Class 2
Laser type	Semiconductor AlGaInP diode laser
Laser power	1 mW
Laser wavelength	635 nm (red)

## Data communication interfaces

Wi-Fi	Peer to peer (ad hoc) or infrastructure (network)
SD Card	One card slot for removable SD memory cards
Audio	Microphone headset via Bluetooth for voice annotation of images
USB	<ul style="list-style-type: none"><li>• USB-A: Connect external USB device</li><li>• USB Mini-B: Data transfer to and from PC / Uncompressed colorized video</li></ul>
USB, standard	USB Mini-B: 2.0
USB, connector type	<ul style="list-style-type: none"><li>• USB-A connector</li><li>• USB Mini-B connector</li></ul>

## Composite video

Video out	Composite
Video, standard	CVBS (ITU-R-BT.470 PAL/SMPTE 170M NTSC)
Video, connector type	4-pole 3.5 mm jack

## Power system

Battery type	Rechargeable Li Ion battery
Battery voltage	3.7 V
Battery capacity	4.4 Ah, at +20°C to +25°C (+68°F to +77°F)
Battery operating time	Approx. 4 hours at +25°C (+77°F) ambient temperature and typical use
Charging system	In camera (AC adapter or 12 V from a vehicle) or 2-bay charger
Charging time	4 h to 90% capacity, charging status indicated by LED's
Charging temperature	0°C to +45°C (+32°F to +113°F)
Power management	Automatic shutdown and sleep mode (user selectable)
AC operation	AC adapter, 90–260 VAC input, 12 V output to camera
Start-up time from sleep mode	Instant on

## Environmental data

Operating temperature range	–15°C to +50°C (+5°F to +122°F)
Storage temperature range	–40°C to +70°C (–40°F to +158°F)
Humidity (operating and storage)	IEC 60068-2-30/24 h 95% relative humidity +25°C to +40°C (+77°F to +104°F) / 2 cycles
EMC	<ul style="list-style-type: none"><li>• ETSI EN 301 489-1 (radio)</li><li>• EN 61000-6-2 (Immunity)</li><li>• EN 61000-6-3 (Emission)</li><li>• FCC 47 CFR Part 15 B (Emission)</li></ul>
Magnetic fields	EN 61 000-4-8, Test level 5 for continuous field (Severe industrial environment)
Encapsulation	IP 54 (IEC 60529)
Bump	25 g (IEC 60068-2-29)
Vibration	2 g (IEC 60068-2-6)
Safety	Power supply: CE/PSE/EN/UL/CSA 60950-1

## Physical data

Camera weight, incl. battery	0.825 kg (1.82 lb.)
Camera dimensions (W x H x D)	216 x 97 x 104 mm (8.5 x 3.8 x 4.1 in.)



## FLIR E50 (incl. Wi-Fi)

P/N: 49001-0401

© 2012, FLIR Systems, Inc.  
All rights reserved worldwide.

### Physical data

Material	Polycarbonate + acrylonitrile butadiene styrene (PC-ABS) Thixomold magnesium Thermoplastic elastomer (TPE)
----------	--

Color	Graphite gray and black
-------	-------------------------

### Scope of delivery

- Hard transport case
- Infrared camera with lens
- Battery
- Calibration certificate
- Camera lens cap
- Downloads brochure
- FLIR Tools software CD-ROM
- Handstrap
- Memory card
- Power supply, incl. multi-plugs
- Printed Getting Started Guide
- Printed Important Information Guide
- Service & training brochure
- USB cable
- User documentation CD-ROM
- Video cable
- Warranty extension card

### Optional Accessories

- 1196961 IR lens, f = 30 mm, 15° incl. case
- 1196960 IR lens, f = 10 mm, 45° incl. case
- T910814 Power supply, incl. multi plugs
- T910737 Memory card micro-SD with adapters
- 1910423 USB cable Std A <-> Mini-B
- 1910490 Cigarette lighter adapter kit, 12 VDC, 1.2 m/3.9 ft.
- 1910582 Video cable
- T197771 Bluetooth Headset
- T910972 EX845: Clamp meter + IR therm TRMS 1000A AC/DC
- T910973 MO297: Moisture meter, pinless with memory
- T197752 Battery
- T197935 Transport case Exx
- T197926 Tripod Adapter
- T127100 Sun shield
- T198125 Battery charger, incl. power supply with multi plugs Exx
- 19250-100 IR Window 2 in., North America
- 19251-100 IR Window 3 in., North America
- 19252-100 IR Window 4 in., North America

### Optional Software

- T197717 FLIR Reporter 8.5 SP3, Professional
- T197717L5 FLIR Reporter 8.5 SP3, Professional, 5 user licenses
- T197717L10 FLIR Reporter 8.5 SP3, Professional, 10 user licenses
- T197778 FLIR BuildIR 2.1
- T197778L5 FLIR BuildIR 2.1, 5 user licenses
- T197778L10 FLIR BuildIR 2.1, 10 user licenses
- T197965 FLIR Tools
- T198206 FLIR ResearchIR 3.0
- T198206L5 FLIR ResearchIR 3.0, 5 user licenses
- T198206L10 FLIR ResearchIR 3.0, 10 user licenses
- APP-10000 FLIR Viewer (iPad/iPhone Application)
- DSW-10000 FLIR IR Camera Player
- APP-10002 FLIR Tools Mobile (Android Application)



P/N: 49001-0401

© 2012, FLIR Systems, Inc.  
All rights reserved worldwide.

## 1196961; IR lens, f = 30 mm, 15° incl. case



### General description

The 15° lens is a popular lens accessory and provides 1.7× magnification compared to the standard lens. Ideal for small or distant targets such as overhead power lines.

### Technical data

Field of view (FOV)	15° × 11.25°
Minimum focus distance	1.2 m (3.93 ft.)
Focal length	30.38 mm (1.2 in.)
Spatial resolution (IFOV)	1.31 mrad/0.82 mrad
F-number	1.3
Lens note	When two pieces of data are separated by "/" the first piece of data is for T/B200 and T/B250 and the second piece of data is for T/B360, T/B400 and A320/A325
Weight	0.092 kg (0.203 lb.), incl. two lens caps
Size (L × D)	24 × 58 mm (1.0 × 2.3 in.)

### Scope of delivery

- Lens
- Lens case

v1.02

## 1196960; IR lens, f = 10 mm, 45° incl. case



### General description

This wide angle lens has a field of view almost double that of the standard lens. Perfect for wide or tall targets or when working in crowded spaces.

### Technical data

Field of view (FOV)	45° × 33.8°
Minimum focus distance	0.20 m (0.66 ft.)
Focal length	9.66 mm (0.38 in.)
Spatial resolution (IFOV)	3.93 mrad/2.45 mrad
F-number	1.3
Lens note	When two pieces of data are separated by "/" the first piece of data is for T/B200 and T/B250 and the second piece of data is for T/B360, T/B400 and A320/A325

**P/N: 49001-0401**

© 2012, FLIR Systems, Inc.  
All rights reserved worldwide.

**Technical data**

Size (L x D) 38 x 47 mm (1.5 x 1.9 in.)

**Scope of delivery**

- Lens
- Lens case

v1.01

## T910814; Power supply, incl. multi plugs



**General description**

FLIR P/B/SC6xx and FLIR GF3xx series:  
Power supply, including multiple plugs, to charge the battery when it is inside or outside of the camera.

FLIR T6xx and FLIR Exx series:  
Power supply, including multiple plugs, to charge the battery when it is inside the camera or in the battery charger.

**Technical data**

AC operation 100–240 VAC, 50/60 Hz, 12 VDC out  
 Power 3000 mA at 12 VDC  
 Cable length 1.98 m (6.5 ft.)

**Scope of delivery**

- Power supply including cable
- EU plug
- UK plug
- US plug
- AU plug

v1.03

## T910737; Memory card micro-SD with adapters



**General description**

Micro-SD Card for data storage (e.g. images)

**Technical data**

P/N: 49001-0401

© 2012, FLIR Systems, Inc.  
All rights reserved worldwide.

### Scope of delivery

- micro-SD
- Adapter to miniSD Card
- Adapter from miniSD Card to SD memory card

v1.03

## 1910423; USB cable Std A <-> Mini-B



### General description

This cable is used to connect the infrared camera with a computer, using the USB protocol.

### Technical data

Weight	60 g (2.1 oz.)
Cable length	1.8 m (5.9 ft.)
Connector	Standard USB-A to USB Mini-B

v1.02

## 1910490; Cigarette lighter adapter kit, 12 VDC, 1.2 m/3.9 ft.



### General description

This cable is used to power the infrared camera from the cigarette lighter socket in a car.

Note: This is the same product as p/n 1196497.

### Technical data

Cable length	1.2 m (3.9 ft.)
--------------	-----------------

v1.01

P/N: 49001-0401

© 2012, FLIR Systems, Inc.  
All rights reserved worldwide.

## 1910582; Video cable



### General description

This cable is used to transfer video signals from the infrared camera to an external monitor, or to a computer featuring an internal video card.

### Technical data

Cable length	1.9 m (6.2 ft.)
Connector	3.5 mm (four pin) plug to RCA (red, white, yellow)

v1.01

## T197771; Bluetooth Headset



### General description

Headset with Bluetooth for wireless connection with the infrared camera.

### Technical data

Bluetooth	Connection to the infrared camera
Audio	Headset including microphone

### Scope of delivery

- Headset
- Ear clip
- Charger
- Multi plugs
- USB cable Std A to Mini-B

v1.10

P/N: 49001-0401

© 2012, FLIR Systems, Inc.  
All rights reserved worldwide.

## T910972; EX845: Clamp meter + IR therm TRMS 1000A AC/DC



### General description

Bluetooth Transmitter with METERLiNK™

Wirelessly transmits Voltage and Current readings to your FLIR high-definition infrared camera to incorporate meter readings with thermal images.

For more info see [www.extech.com](http://www.extech.com)

METERLiNK™ makes it easy for a thermographer to quickly take electrical readings using an Extech EX845 clamp meter and instantly record them right on an infrared image. METERLiNK™ accelerates infrared inspections and diagnostics while adding value to your reports by increasing the amount of detail you provide.

### EX845 CAT IV Clamp Meter Features:

- Patented built-in non-contact IR Thermometer design with laser pointer
- True RMS Current and Voltage measurements
- Peak hold captures inrush currents and Transients
- MultiMeter functions include AC/DC Voltage, Resistance, Capacitance, Frequency, Diode, and Continuity
- 1.7" (43mm) jaw opening for conductors up to 750MCM or two 500MCM
- 4000 count backlit display
- Features include Data Hold and Min/Max and Auto Power off
- Autoranging with manual range button
- Complete with CAT IV test leads, 9V battery, Type K probe (-22 to 572°F/-30 to 300°C), pouch case, and Professional Test Lead Set

### Professional Test Lead Features:

- 8-Piece Professional Test Lead set
- Two 42" (1m) PVC lead extensions with shrouded banana plugs at both ends
- Two modular 4" (102mm) Heavy Duty test probe handles with 0.16" (4mm) banana plug tip
- Two standard size, alligator clips with insulated rubber boot
- Two extra large, double-insulated, alligator clips with sharp teeth for piercing insulated wire. Jaws open to 0.8" (20mm)

v1.0

P/N: 49001-0401

© 2012, FLIR Systems, Inc.  
All rights reserved worldwide.

## T910973; MO297: Moisture meter, pinless with memory



### General description

Bluetooth Transmitter with MeterLink™

Wirelessly transmits moisture and humidity data to your FLIR high-definition infrared camera to incorporate meter readings with thermal images.

For more info see [www.extech.com](http://www.extech.com)

FLIR infrared cameras rapidly reveal moisture problems in homes and commercial structures. Documenting water damage with a moisture meter can provide valuable added details about moisture issues. The process of correlating readings to infrared images however is awkward, imprecise and prone to errors. METERLINK™ expedites building inspections by annotating several moisture-related readings from damaged surfaces directly onto the related infrared image. METERLINK™ increases accuracy and eliminates confusion about which moisture readings pertain to which images.

### Key features:

- Quickly indicates the moisture content of materials with Pinless technology without damaging the surface; Remote Pin-type probe (MO290-P included) allows for contact moisture readings (3ft/0.9m cable length)
- Manually store/recall up to 20 labeled readings
- Works on multiple wood types and other building materials
- Easy to read, large dual display with automatic backlight feature
- Simultaneously displays moisture value of wood or material being tested, Air Temperature, IR Temperature, or Humidity
- Pinless measurement depth to 0.75" (19mm) below the surface
- Programmable high/low Moisture and Humidity alarms
- Designed with a patented IR circuit to measure non-contact surface temperature; 8:1 distance to spot ratio with 0.95 fixed emissivity
- Built-in Humidity/Temperature probe measures Relative Humidity, Air Temperature plus Grains Per Pound (GPP)/(g/kg), Dew Point (DP), Vapor Pressure, and condensation point
- Automatic calculation of differential Temperature (IR - DP) to determine condensation point
- Fast Analog Bargraph
- Min/Max and Data Hold
- Auto power off and low battery indication
- Complete with pin moisture probe with cable, 9V battery and case

v1.0

P/N: 49001-0401

© 2012, FLIR Systems, Inc.  
All rights reserved worldwide.

## T197752; Battery



### General description

High capacity battery for the IR camera.

### Technical data

Battery type	Rechargeable Li Ion battery
Battery voltage	3.7 V
Battery capacity	4.4 Ah, at +20°C (+68°F)
Charging temperature	0°C to +45°C (+32°F to +113°F)
Battery storage temperature range	-40°C to +70°C (-40°F to +158°F)
Weight	0.11 kg (0.24 lb.)
Size (L x W x H)	78 x 40 x 22 mm (3.1 x 1.6 x 0.9 in.)

v1.03

## T197935; Transport case Exx



### General description

Rugged, watertight plastic shipping case for FLIR i/bXX. Holds all items neatly and securely. The case can be locked with padlocks and features a breather valve to prevent pressure build-up in airplane cargo holds.

v1.0

## T197926; Tripod Adapter



### General description

**P/N: 49001-0401**

© 2012, FLIR Systems, Inc.  
All rights reserved worldwide.

**Technical data**

Size (L x W x H)	62x 50 x 23 mm (2.5 x 2.0 x 0.9 in.)
Color	Black

**Scope of delivery**

- Tripod Adapter

v1.01

## T127100; Sun shield



**General description**

Sunshield for the FLIR Exx series, to increase visibility of the LCD.

**Technical data**

Size (L x W x H)	40 x 74 x 70 mm (1.6 x 2.9 x 2.8 in.)
Material	Plastic
Color	Black

**Scope of delivery**

- Sun shield

v1.01

## T198125; Battery charger, incl. power supply with multi plugs Exx



**General description**

Stand-alone 2-bay battery charger, including power supply with multi plugs.

**Technical data**

AC operation	100–240 VAC, 50/60 Hz, 12 VDC out
Power	3000 mA at 12 VDC
Size (L x W x H)	133 x 86 x 51 mm (5.3 x 3.4 x 2.0 in.)



P/N: 49001-0401

© 2012, FLIR Systems, Inc.  
All rights reserved worldwide.

### Scope of delivery

- Stand-alone 2-bay battery charger
- Power supply including cable
- EU plug
- UK plug
- US plug
- AU plug

v1.01

## 19250-100; IR Window 2 in., North America



### General description

This device is a viewport which consist of a crystal "glass" window, mounted in an aluminum frame. The glass is specially formulated to allow transmission of infrared light to allow use of infrared thermal sensing equipment without opening the enclosure. This device is intended for installation in doors or walls of electrical enclosures without compromising the integrity of the enclosure.

### Technical data

Voltage	Any range
Environment	Indoor/outdoor type 4/12
Operating temperature range	Maximum: 260°C (500°F)
Storage temperature range	Optics, maximum: 1357°C (2474°F)
Size (L x W x H)	25.5 x 73 x 86 mm (1.0 x 2.87 x 3.36 in.)
Viewing aperture diameter	45 mm (1.77 in.)
Material	Optics: CaF2 (Calcium Fluoride Crystal) Body: Anodized aluminum Hardware: steel
Comments to physical data	Required hole diameter, nominal: 60.3 mm (2.375 in.) Greenlee Punch: 76BB Maximum pullout strength: 658 kg (1450 lb.)
Waveband	Broadband IR: short-, mid-, and longwave
Visible light spectrum	Yes
Certification	UL, IP67, NEMA Type 4/12

### Scope of delivery

- IR window
- Case
- Mounting instruction
- Additional safety screw

v1.03

P/N: 49001-0401

© 2012, FLIR Systems, Inc.  
All rights reserved worldwide.

## 19251-100; IR Window 3 in., North America



### General description

This device is a viewport which consist of a crystal "glass" window, mounted in an aluminum frame. The glass is specially formulated to allow transmission of infrared light to allow use of infrared thermal sensing equipment without opening the enclosure. This device is intended for installation in doors or walls of electrical enclosures without compromising the integrity of the enclosure.

### Technical data

Voltage	Any range
Environment	Indoor/outdoor type 4/12
Operating temperature range	Maximum: 260°C (500°F)
Storage temperature range	Optics, maximum: 1357°C (2474°F)
Size (L x W x H)	26.9 x 99 x 107 mm (1.05 x 3.89 x 4.22 in.)
Viewing aperture diameter	69 mm (2.71 in.)
Material	Optics: CaF2 (Calcium Fluoride Crystal) Body: Anodized aluminum Hardware: steel
Comments to physical data	Required hole diameter, nominal: 88.9 mm (3.5 in.) Greenlee Punch: 739BB Maximum pullout strength: 1656 kg (3650 lb.)
Waveband	Broadband IR: short-, mid-, and longwave
Visible light spectrum	Yes
Certification	UL, IP67, NEMA Type 4/12

### Scope of delivery

- IR window
- Case
- Mounting instruction
- Additional safety screw

v1.03

## 19252-100; IR Window 4 in., North America



### General description

This device is a viewport which consist of a crystal "glass" window, mounted in an aluminum frame. The glass is specially formulated to allow transmission of infrared light to allow use of infrared thermal sensing equipment without opening the enclosure. This device is intended for installation in doors or walls of electrical enclosures without compromising the integrity of the enclosure.



## Optional Accessories

P/N: 49001-0401

© 2012, FLIR Systems, Inc.  
All rights reserved worldwide.

### Technical data

Environment	Indoor/outdoor type 4/12
Operating temperature range	Maximum: 260°C (500°F)
Storage temperature range	Optics, maximum: 1357°C (2474°F)
Size (L x W x H)	29.3 x 127 x 137 mm (1.15 x 5.01 x 5.37 in.)
Viewing aperture diameter	89 mm (3.50 in.)
Material	Optics: CaF <sub>2</sub> (Calcium Fluoride Crystal) Body: Anodized aluminum Hardware: steel
Comments to physical data	Required hole diameter, nominal: 114.3 mm (4.5 in.) Greenlee Punch: 742BB Maximum pullout strength: 1678 kg (3700 lb.)
Waveband	Broadband IR: short-, mid-, and longwave
Visible light spectrum	Yes
Certification	UL, IP67, NEMA Type 4/12

### Scope of delivery

- IR window
- Case
- Mounting instruction
- Additional safety screw

v1.03

P/N: 49001-0401

© 2012, FLIR Systems, Inc.  
All rights reserved worldwide.

## T197717; FLIR Reporter 8.5 SP3, Professional

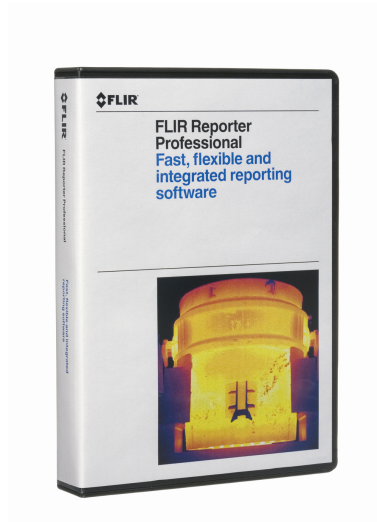

### General description

FLIR Reporter Professional is a powerful software for creating compelling and professional, fully customized, easy-to-interpret maintenance reports.

Professional Report Wizard guides you step-by-step in combining all IR inspection data - infrared and visual images, temperature measurements, and text notes - into a professional, easy-to-interpret maintenance report.

### Key features:

- Flexible report page design and layout for customized reports
- Use quick insert function to easily create custom report pages
- Fully integrated with standard Microsoft Word
- Generates reports in standard MS Office format and PDF-format
- Powerful temperature analysis
- Triple Fusion Picture-in-Picture (movable, sizable, scalable)
- Rapid report manager supporting automatic report generation by drag-and-drop
- Trending functionality
- Automatic link to Google™ Maps for images with GPS coordinates
- Automatic summary table for the report
- Fine tune images and make full temperature analysis directly in Microsoft Word
- Spell check
- Create your own formulas including measurement values from images
- Play radiometric sequences directly in the report
- Search functionality to quickly finding images for your report
- Panorama tool for combining several images to a larger image
- Support for GF series IR images
- Auto Update function
- Office 2003 (32-bit), Office 2007 (32-bit) and Office 2010 (32-bit)
- Windows 7 (32 and 64-bit), Windows Vista (32 and 64-bit)
- Support for MeterLink™ data
- \*.docx compatibility

### Download

<http://support.flir.com/SwDownload/app/RssSWDownload.aspx?ID=93>

### Release notes

Version	8.5 SP3
New features	<ul style="list-style-type: none"> <li>• --- News in SP3:</li> <li>• Ability to save sessions as files (previously only save/open a session). (Professional Report Wizard)</li> <li>• Profile Open/Save settings for the properties file. (Professional Report Wizard)</li> <li>• --- News in SP2:</li> <li>• Office 2010 (32 bit)</li> <li>• Minor bug fixes</li> <li>• --- News in SP1:</li> <li>• Full support for Windows® 7</li> <li>• Support for MeterLink™ data</li> <li>• *.docx compatibility</li> </ul>

### Scope of delivery

P/N: 49001-0401

© 2012, FLIR Systems, Inc.  
All rights reserved worldwide.

## System requirements

Operating system	<ul style="list-style-type: none"><li>• Windows XP, 32-bit</li><li>• Windows Vista, 32-bit</li><li>• Windows Vista, 64-bit</li><li>• Windows 7, 32-bit</li><li>• Windows 7, 64-bit</li></ul>
Software requirements	<ul style="list-style-type: none"><li>• Office 2003 (32-bit)</li><li>• Office 2007 (32-bit)</li><li>• Office 2010 (32-bit)</li></ul>

v1.04

## T197717L5; FLIR Reporter 8.5 SP3, Professional, 5 user licenses

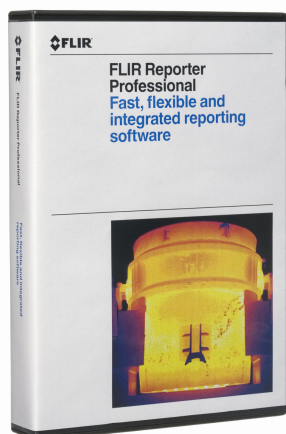

### General description

FLIR Reporter Professional is a powerful software for creating compelling and professional, fully customized, easy-to-interpret maintenance reports.

Professional Report Wizard guides you step-by-step in combining all IR inspection data - infrared and visual images, temperature measurements, and text notes - into a professional, easy-to-interpret maintenance report.

#### Key features:

- Flexible report page design and layout for customized reports
- Use quick insert function to easily create custom report pages
- Fully integrated with standard Microsoft Word
- Generates reports in standard MS Office format and PDF-format
- Powerful temperature analysis
- Triple Fusion Picture-in-Picture (movable, sizable, scalable)
- Rapid report manager supporting automatic report generation by drag-and-drop
- Trending functionality
- Automatic link to Google™ Maps for images with GPS coordinates
- Automatic summary table for the report
- Fine tune images and make full temperature analysis directly in Microsoft Word
- Spell check
- Create your own formulas including measurement values from images
- Play radiometric sequences directly in the report
- Search functionality to quickly finding images for your report
- Panorama tool for combining several images to a larger image
- Support for GF series IR images
- Auto Update function
- Office 2003 (32-bit), Office 2007 (32-bit) and Office 2010 (32-bit)
- Windows 7 (32 and 64-bit), Windows Vista (32 and 64-bit)
- Support for MeterLink™ data
- \*.docx compatibility

### Download

<http://support.flir.com/SwDownload/app/RssSWDownload.aspx?ID=93>

P/N: 49001-0401

© 2012, FLIR Systems, Inc.  
All rights reserved worldwide.

### Release notes

#### New features

- --- News in SP3:
- Ability to save sessions as files (previously only save/open a session). (Professional Report Wizard)
- Profile Open/Save settings for the properties file. (Professional Report Wizard)
- --- News in SP2:
- Office 2010 (32 bit)
- Minor bug fixes
- --- News in SP1:
- Full support for Windows® 7
- Support for MeterLink™ data
- \*.docx compatibility

### Scope of delivery

- FLIR Reporter Professional
- Getting Starting Guide
- 5 user licenses

### System requirements

#### Operating system

- Windows XP, 32-bit
- Windows Vista, 32-bit
- Windows Vista, 64-bit
- Windows 7, 32-bit
- Windows 7, 64-bit

#### Software requirements

- Office 2003 (32-bit)
- Office 2007 (32-bit)
- Office 2010 (32-bit)

v1.03

## T197717L10; FLIR Reporter 8.5 SP3, Professional, 10 user licenses

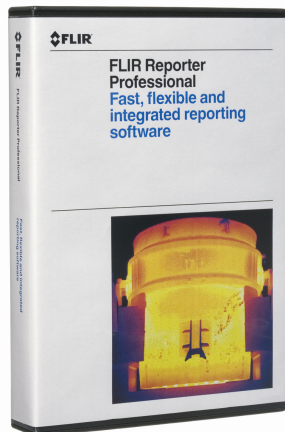

### General description

FLIR Reporter Professional is a powerful software for creating compelling and professional, fully customized, easy-to-interpret maintenance reports.

Professional Report Wizard guides you step-by-step in combining all IR inspection data - infrared and visual images, temperature measurements, and text notes – into a professional, easy-to-interpret maintenance report.

Key features:

P/N: 49001-0401

© 2012, FLIR Systems, Inc.  
All rights reserved worldwide.

## General description

- Flexible report page design and layout for customized reports
- Use quick insert function to easily create custom report pages
- Fully integrated with standard Microsoft Word
- Generates reports in standard MS Office format and PDF-format
- Powerful temperature analysis
- Triple Fusion Picture-in-Picture (movable, sizable, scalable)
- Rapid report manager supporting automatic report generation by drag-and-drop
- Trending functionality
- Automatic link to Google™ Maps for images with GPS coordinates
- Automatic summary table for the report
- Fine tune images and make full temperature analysis directly in Microsoft Word
- Spell check
- Create your own formulas including measurement values from images
- Play radiometric sequences directly in the report
- Search functionality to quickly finding images for your report
- Panorama tool for combining several images to a larger image
- Support for GF series IR images
- Auto Update function
- Office 2003 (32-bit), Office 2007 (32-bit) and Office 2010 (32-bit)
- Windows 7 (32 and 64-bit), Windows Vista (32 and 64-bit)
- Support for MeterLink™ data
- \*.docx compatibility

## Download

<http://support.flir.com/SwDownload/app/RssSWDownload.aspx?ID=93>

## Release notes

Version	8.5 SP3
New features	<ul style="list-style-type: none"> <li>• --- News in SP3:</li> <li>• Ability to save sessions as files (previously only save/open a session). (Professional Report Wizard)</li> <li>• Profile Open/Save settings for the properties file. (Professional Report Wizard)</li> <li>• --- News in SP2:</li> <li>• Office 2010 (32 bit)</li> <li>• Minor bug fixes</li> <li>• --- News in SP1:</li> <li>• Full support for Windows® 7</li> <li>• Support for MeterLink™ data</li> <li>• *.docx compatibility</li> </ul>

## Scope of delivery

- FLIR Reporter Professional
- Getting Starting Guide
- 10 user licenses

## System requirements

Operating system	<ul style="list-style-type: none"> <li>• Windows XP, 32-bit</li> <li>• Windows Vista, 32-bit</li> <li>• Windows Vista, 64-bit</li> <li>• Windows 7, 32-bit</li> <li>• Windows 7, 64-bit</li> </ul>
Software requirements	<ul style="list-style-type: none"> <li>• Office 2003 (32-bit)</li> <li>• Office 2007 (32-bit)</li> <li>• Office 2010 (32-bit)</li> </ul>

v1.03

P/N: 49001-0401

© 2012, FLIR Systems, Inc.  
All rights reserved worldwide.

## T197778; FLIR BuildIR 2.1

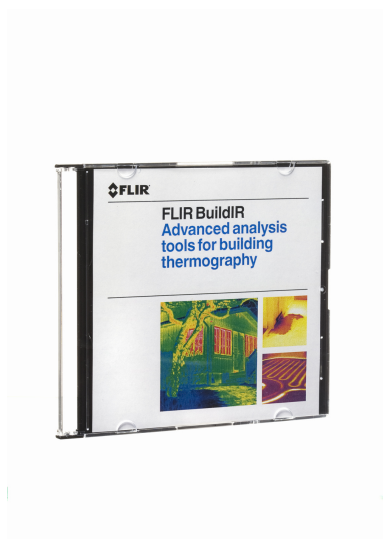

### General description

FLIR BuildIR is a dedicated and flexible software package for advanced analyses of building-related applications. Make the work of building-related analyses considerably easier - organize, analyze, report. Increase the speed and quality of your reports.

#### Key features:

- See, quantify, and estimate potential energy cost savings.
- Image fusion.
- Facility to assess the scope of damage/problems.
- Customized report templates for air infiltration, moisture, insulation deficiencies, and estimation of potential energy savings.
- Panorama functionality: automatically create one image from several to cover large objects or increase resolution, including perspective corrections and crop function.
- Link and unlink files.
- Create a graph of the conditions during an inspection.
- Auto update function.
- Support for MeterLink data.
- Support for Microsoft Windows 7.

### Download

To download, click the following link (a 30 day demo version available):

<http://support.flir.com/SwDownload/app/RssSWDownload.aspx?ID=87>

### Release notes

Version	FLIR BuildIR 2.1 SP3
New features	<ul style="list-style-type: none"> <li>• --- News in SP3:                             <ul style="list-style-type: none"> <li>• New user interface design</li> <li>• Various bug fixes</li> </ul> </li> <li>• --- News in SP2:                             <ul style="list-style-type: none"> <li>• Insulation alarm inverts cold/hot</li> <li>• IFOV implementation</li> <li>• Option to navigate between folders in the Tools tab.</li> <li>• Performance improvements</li> <li>• Faster application start-up</li> <li>• Various bug fixes</li> </ul> </li> </ul>

### Scope of delivery

- FLIR BuildIR

### System requirements

- |                  |  |
|------------------|--|
| Operating system | <ul style="list-style-type: none"> <li>• Windows XP, 32-bit</li> <li>• Windows Vista, 32-bit/64-bit</li> <li>• Windows 7, 32 bit/64 bit</li> </ul> |
|------------------|--|



P/N: 49001-0401

© 2012, FLIR Systems, Inc.  
All rights reserved worldwide.

## T197778L5; FLIR BuildIR 2.1, 5 user licenses

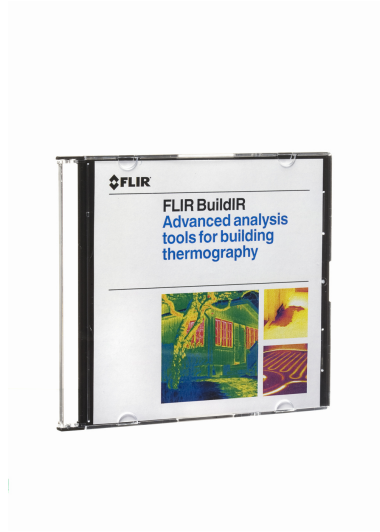

### General description

FLIR BuildIR is a dedicated and flexible software package for advanced analyses of building-related applications. Make the work of building-related analyses considerably easier - organize, analyze, report. Increase the speed and quality of your reports.

#### Key features:

- See, quantify, and estimate potential energy cost savings.
- Image fusion.
- Facility to assess the scope of damage/problems.
- Customized report templates for air infiltration, moisture, insulation deficiencies, and estimation of potential energy savings.
- Panorama functionality: automatically create one image from several to cover large objects or increase resolution, including perspective corrections and crop function.
- Link and unlink files.
- Create a graph of the conditions during an inspection.
- Auto update function.
- Support for MeterLink data.
- Support for Microsoft Windows 7.

### Download

To download, click the following link (a 30 day demo version available):

<http://support.flir.com/SwDownload/app/RssSWDownload.aspx?ID=87>

### Release notes

Version	FLIR BuildIR 2.1 SP3
New features	<ul style="list-style-type: none"> <li>• --- News in SP3:</li> <li>• New user interface design</li> <li>• Various bug fixes</li> <li>• --- News in SP2:</li> <li>• Insulation alarm inverts cold/hot</li> <li>• IFOV implementation</li> <li>• Option to navigate between folders in the Tools tab.</li> <li>• Performance improvements</li> <li>• Faster application start-up</li> <li>• Various bug fixes</li> </ul>

### Scope of delivery

- FLIR BuildIR
- 5 user licenses

### System requirements

Operating system	<ul style="list-style-type: none"> <li>• Windows XP, 32-bit</li> <li>• Windows Vista, 32-bit/64-bit</li> <li>• Windows 7, 32 bit/64 bit</li> </ul>
------------------	--

P/N: 49001-0401

© 2012, FLIR Systems, Inc.  
All rights reserved worldwide.

## T197778L10; FLIR BuildIR 2.1, 10 user licenses

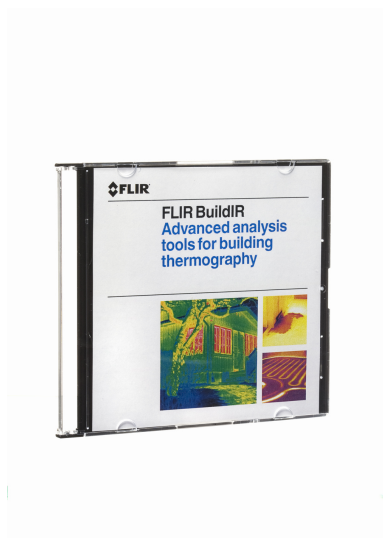

### General description

FLIR BuildIR is a dedicated and flexible software package for advanced analyses of building-related applications. Make the work of building-related analyses considerably easier - organize, analyze, report. Increase the speed and quality of your reports.

#### Key features:

- See, quantify, and estimate potential energy cost savings.
- Image fusion.
- Facility to assess the scope of damage/problems.
- Customized report templates for air infiltration, moisture, insulation deficiencies, and estimation of potential energy savings.
- Panorama functionality: automatically create one image from several to cover large objects or increase resolution, including perspective corrections and crop function.
- Link and unlink files.
- Create a graph of the conditions during an inspection.
- Auto update function.
- Support for MeterLink data.
- Support for Microsoft Windows 7.

### Download

To download, click the following link (a 30 day demo version available):

<http://support.flir.com/SwDownload/app/RssSWDownload.aspx?ID=87>

### Release notes

Version	FLIR BuildIR 2.1 SP3
New features	<ul style="list-style-type: none"> <li>• --- News in SP3:</li> <li>• New user interface design</li> <li>• Various bug fixes</li> <li>• --- News in SP2:</li> <li>• Insulation alarm inverts cold/hot</li> <li>• IFOV implementation</li> <li>• Option to navigate between folders in the Tools tab.</li> <li>• Performance improvements</li> <li>• Faster application start-up</li> <li>• Various bug fixes</li> </ul>

### Scope of delivery

- FLIR BuildIR
- 10 user licenses

### System requirements

Operating system	<ul style="list-style-type: none"> <li>• Windows XP, 32-bit</li> <li>• Windows Vista, 32-bit/64-bit</li> <li>• Windows 7, 32 bit/64 bit</li> </ul>
------------------	--

P/N: 49001-0401

© 2012, FLIR Systems, Inc.  
All rights reserved worldwide.

## T197965; FLIR Tools



### General description

FLIR Tools is a software suite specifically designed to provide an easy way to update your camera and create inspection reports.

#### Key features:

- Report templates (horizontal IR + DC, vertical IR + DC, horizontal IR + IR).
- Import images from your camera to your computer.
- Apply filters when searching for images.
- Search in all texts in images and text annotations.
- Store the five latest search criterias.
- Lay out, move, and resize measurement tools on any infrared image.
- Create PDF imagesheets of any images of your choice.
- Add headers, footers, and logos to the imagesheets.
- Create PDF reports of any images of your choice.
- Add headers, footers, and logotypes to the report.
- Report editor (report page preview and snap to grid).
- Sort function (by date, groups sorted by by path and groups sorted by date)
- Browse and purchase infrared cameras, software, and accessories in our webshop.
- Software localized to 21 languages.
- Camera update (applies to FLIR Exx and T6xx series only).

### Download

This software is a freeware. To download, click the following link:

<http://support.flir.com/SwDownload/app/RssSWDownload.aspx?ID=120>

### Release notes

Version	FLIR Tools 2.0
New features	<ul style="list-style-type: none"> <li>• --- News in 2.0: ---</li> <li>• Camera tab (Camera connection with FLIR UVC cameras. Measurement data analysis. Plotting. Snapshot saving with text annotation and plot.)</li> <li>• Performance improvement for large reports: can now create reports and imagesheets of up to 200 pages.</li> <li>• Various bug fixes.</li> </ul>

### Scope of delivery

- Digital download, or
- CD-ROM

### System requirements

Operating system	<ul style="list-style-type: none"> <li>• Windows XP, 32-bit</li> <li>• Windows Vista, 32-bit</li> <li>• Windows 7, 32-bit</li> <li>• Windows 7, 64 bit</li> </ul>
------------------	---

P/N: 49001-0401

© 2012, FLIR Systems, Inc.  
All rights reserved worldwide.

## T198206; FLIR ResearchIR 3.0

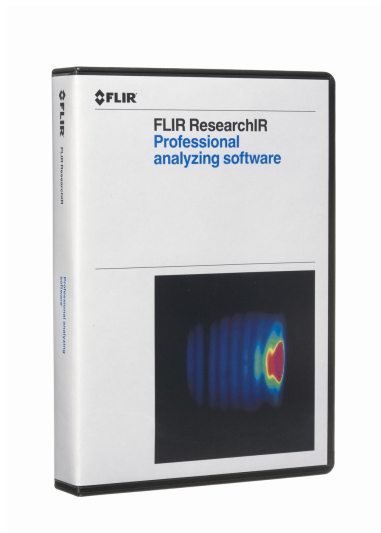

### General description

FLIR ResearchIR is aimed at R&D users of uncooled infrared cameras who want an analysis of thermal events for design, product, or process reasons. FLIR ResearchIR gets the most from your infrared camera and allows high-speed recording and advanced thermal pattern analysis. Its powerful recording and processing options make FLIR ResearchIR the perfect companion for R&D work.

#### Key features:

- Visualizes thermal patterns.
- Flexible and ergonomic user interface.
- Powerful high-speed recording options with conditional start/stop.
- Advanced playback controls.
- Multiple measurement tools (line profile, area, spot).
- Emissivity calculator.
- Delta measurement.
- Processing filter chain with averaging, subtraction, and sliding subtraction.
- Advanced image colorization (multiple color palettes, color distribution patterns, advanced isotherms).
- Advanced export options (image, plot, and profile to the clipboard or a file either as a picture, movie, or CSV data)
- Fusion on still images.
- Contrast and palette isotherm.

#### Typical applications:

- The transient behavior of a power supply or one of its components during power up when altering the load or any other parameter.
- Evaluating the transient behavior of a car brake when braking and when altering the material in the brakes.

### Download

<http://support.flir.com/SwDownload/app/RssSWDownload.aspx?ID=132>

### Release notes

Version	FLIR ResearchIR 3.0
New features	• --- News in 3.0:

### Scope of delivery

- FLIR ResearchIR
- Getting Starting Guide

### System requirements

Operating system	<ul style="list-style-type: none"> <li>• Windows XP, 32 bit</li> <li>• Windows Vista, 32 bit</li> <li>• Windows Vista, 64 bit</li> <li>• Windows 7, 32 bit</li> <li>• Windows 7, 64 bit</li> </ul>
------------------	--

P/N: 49001-0401

© 2012, FLIR Systems, Inc.  
All rights reserved worldwide.

## T198206L5; FLIR ResearchIR 3.0, 5 user licenses

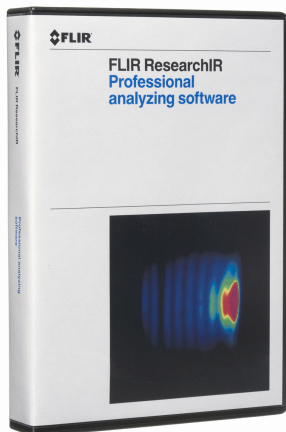

### General description

FLIR ResearchIR is aimed at R&D users of uncooled infrared cameras who want an analysis of thermal events for design, product, or process reasons. FLIR ResearchIR gets the most from your infrared camera and allows high-speed recording and advanced thermal pattern analysis. Its powerful recording and processing options make FLIR ResearchIR the perfect companion for R&D work.

#### Key features:

- Visualizes thermal patterns.
- Flexible and ergonomic user interface.
- Powerful high-speed recording options with conditional start/stop.
- Advanced playback controls.
- Multiple measurement tools (line profile, area, spot).
- Emissivity calculator.
- Delta measurement.
- Processing filter chain with averaging, subtraction, and sliding subtraction.
- Advanced image colorization (multiple color palettes, color distribution patterns, advanced isotherms).
- Advanced export options (image, plot, and profile to the clipboard or a file either as a picture, movie, or CSV data)
- Fusion on still images.
- Contrast and palette isotherm.

#### Typical applications:

- The transient behavior of a power supply or one of its components during power up when altering the load or any other parameter.
- Evaluating the transient behavior of a car brake when braking and when altering the material in the brakes.

### Download

<http://support.flir.com/SwDownload/app/RssSWDownload.aspx?ID=132>

### Release notes

Version	FLIR ResearchIR 3.0
New features	• --- News in 3.0:

### Scope of delivery

- FLIR ResearchIR
- Getting Starting Guide
- 5 user licenses

### System requirements

Operating system	<ul style="list-style-type: none"> <li>• Windows XP, 32 bit</li> <li>• Windows Vista, 32 bit</li> <li>• Windows Vista, 64 bit</li> <li>• Windows 7, 32 bit</li> <li>• Windows 7, 64 bit</li> </ul>
------------------	--

P/N: 49001-0401

© 2012, FLIR Systems, Inc.  
All rights reserved worldwide.

## T198206L10; FLIR ResearchIR 3.0, 10 user licenses

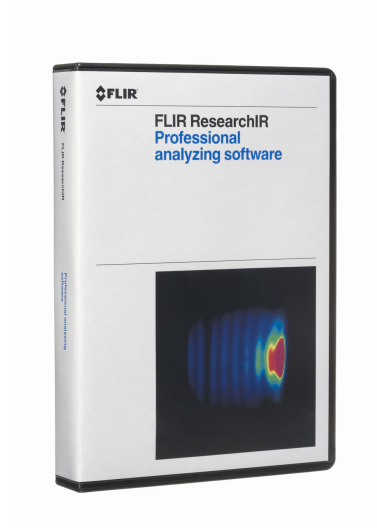

### General description

FLIR ResearchIR is aimed at R&D users of uncooled infrared cameras who want an analysis of thermal events for design, product, or process reasons. FLIR ResearchIR gets the most from your infrared camera and allows high-speed recording and advanced thermal pattern analysis. Its powerful recording and processing options make FLIR ResearchIR the perfect companion for R&D work.

#### Key features:

- Visualizes thermal patterns.
- Flexible and ergonomic user interface.
- Powerful high-speed recording options with conditional start/stop.
- Advanced playback controls.
- Multiple measurement tools (line profile, area, spot).
- Emissivity calculator.
- Delta measurement.
- Processing filter chain with averaging, subtraction, and sliding subtraction.
- Advanced image colorization (multiple color palettes, color distribution patterns, advanced isotherms).
- Advanced export options (image, plot, and profile to the clipboard or a file either as a picture, movie, or CSV data).
- Fusion on still images.
- Contrast and palette isotherm.

#### Typical applications:

- The transient behavior of a power supply or one of its components during power up when altering the load or any other parameter.
- Evaluating the transient behavior of a car brake when braking and when altering the material in the brakes.

### Download

<http://support.flir.com/SwDownload/app/RssSWDownload.aspx?ID=132>

### Release notes

Version	FLIR ResearchIR 3.0
New features	• --- News in 3.0:

### Scope of delivery

- FLIR ResearchIR
- Getting Starting Guide
- 10 user licenses

### System requirements

Operating system	<ul style="list-style-type: none"> <li>• Windows XP, 32 bit</li> <li>• Windows Vista, 32 bit</li> <li>• Windows Vista, 64 bit</li> <li>• Windows 7, 32 bit</li> <li>• Windows 7, 64 bit</li> </ul>
------------------	--

P/N: 49001-0401

© 2012, FLIR Systems, Inc.  
All rights reserved worldwide.

## APP-10000; FLIR Viewer (iPad/iPhone Application)



### General description

FLIR Viewer - an intuitive iPhone/iPad app for analyzing, managing, and distributing infrared images. With FLIR Viewer, you can exchange images between your camera and wireless device, analyze images (spot, level span and palette), read GPS position and map information, generate and email pdf-reports directly on an iPhone, iPod Touch or iPad.

### Key features:

- Import images from your infrared camera.
- Lay out and move measurement tools on the image.
- Read out temperature measurements.
- Zoom in on images.
- On the iPhone/iPad, remotely take snapshots when a camera is connected.
- On the camera, take snapshots that will automatically be saved on the iPhone/iPad.
- Delete images on the iPhone/iPad.
- Display an image's GPS coordinates on Google Maps.
- Create and e-mail imagesheets.
- Create and e-mail reports.
- Print imagesheets and reports with any AirPrint-enabled printer.
- Save images in the iPhone/iPad photo library.
- Save PDF reports in image folders.
- Send images to FTP sites and other file-sharing services (Dropbox, Box.net, etc.).
- Display image information, e.g., object parameters, text comments, file details.
- Scale indicators when changing the level/span.
- Play back voice comments.
- Change the level and span.
- Change general settings in the app.
- Change the palette.

### FLIR Viewer PRO adds FTP and image management features:

- FTP (Uploading images to a server)
- Box support
- DropBox support
- Downloadable palettes
- Area, Line and Circle tools
- Automatic hot and cold detection
- DeltaT
- Possibility to add your own logo to the reports

### Download

The application can be downloaded from App Store, see the link below.

<http://itunes.apple.com/se/app/flir-ir-viewer/id408847159?mt=8#ls=1>

### Release notes

Version	FLIR Viewer 1.1.1
New features	<ul style="list-style-type: none"> <li>• --- News in 1.1.1</li> <li>• Easier method to select a customer logo.</li> <li>• Additional properties now added. e.g., image size, camera type, and lens type.</li> <li>• Updated translations.</li> <li>• Various bug fixes.</li> </ul>

### System requirements

Operating system	• iOS 4.0 or higher
Hardware requirements	• iPhone

P/N: 49001-0401

© 2012, FLIR Systems, Inc.  
All rights reserved worldwide.

## System requirements

v1.04

## DSW-10000; FLIR IR Camera Player

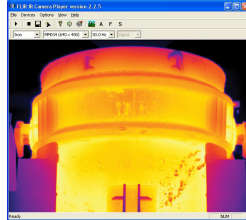

### General description

FLIR IR Camera Player is a PC-based remote control and viewer that you can use with cameras from FLIR Systems.

You can perform one or more of the following with FLIR IR Camera Player:

- Record a video stream from the camera.
- Save a frame from the video stream as a snapshot image (\*.bmp).
- Autofocus, focus far, and focus near.
- Autoadjust the camera image.
- Freeze the camera image.
- Save a camera image in the camera.
- Change Color palette.
- Add an image description and a text comment to an image.

You connect a camera in one of the following ways:

- Ethernet
- FireWire
- USB

### Download

This software is a freeware. To download, click the following link:

<http://support.flir.com/SwDownload/app/RssSWDownload.aspx?ID=89>

### Release notes

Version	2.2.6
New features	<ul style="list-style-type: none"> <li>• --- News in 2.2.6</li> <li>• Various bug fixes.</li> <li>• --- News in 2.2.5</li> <li>• Color palette menu.</li> <li>• Option to record AVI video clips from cameras that deliver MPEG or H264 image streams.</li> <li>• Option to compress the FLIR Researcher formats F7M0 and F7M2 to AVI.</li> <li>• Support for FLIR Exx series cameras.</li> <li>• Support for FLIR T6xx series cameras.</li> </ul>

### System requirements

Operating system	<ul style="list-style-type: none"> <li>• Windows XP, 32-bit</li> <li>• Windows Vista, 32-bit/64-bit</li> <li>• Windows 7, 32-bit/64-bit</li> </ul>
------------------	--

v1.02



P/N: 49001-0401

© 2012, FLIR Systems, Inc.  
All rights reserved worldwide.

## APP-10002; FLIR Tools Mobile (Android Application)



### General description

FLIR Tools Mobile is an intuitive Android app for analyzing, managing, and distributing infrared images.

#### Key features:

- Import images from your Wi-Fi-enabled infrared camera.
- Lay out and move measurement tools on the image.
- Read out temperature measurements.
- Zoom in on images.
- On the Android phone/tablet, remotely take snapshots when a camera is connected.
- On the camera, take snapshots that will automatically be saved on the Android phone/tablet.
- Delete images on the Android phone/tablet.
- Display an image's GPS coordinates on Google Maps.
- Create and e-mail reports.
- Save images in the Android phone/tablet photo library.
- Send images to FTP sites and other file-sharing services (DropBox, Box.net, etc.).
- Display image information, e.g., object parameters, text comments, and file details.
- Play back voice comments.
- Change the level and span.
- Change general settings in the app.
- Change the palette.
- Help files in 21 languages.

### Download

The application can be downloaded from Android Market, see the link below.

<https://market.android.com/details?id=com.flir.viewer>

### Release notes

Version	FLIR Tools Mobile 1.0.1
New features	<ul style="list-style-type: none"> <li>• --- News in 1.0.1 ---</li> <li>• Greek and Russian language support for PDF export now enabled.</li> <li>• Help files now translated into 21 languages.</li> <li>• Various bug fixes and optimizations.</li> </ul>

### System requirements

Operating system	• Android 2.3 and later
------------------	-------------------------

v1.03

© 2011, FLIR Systems, Inc.  
All rights reserved worldwide.

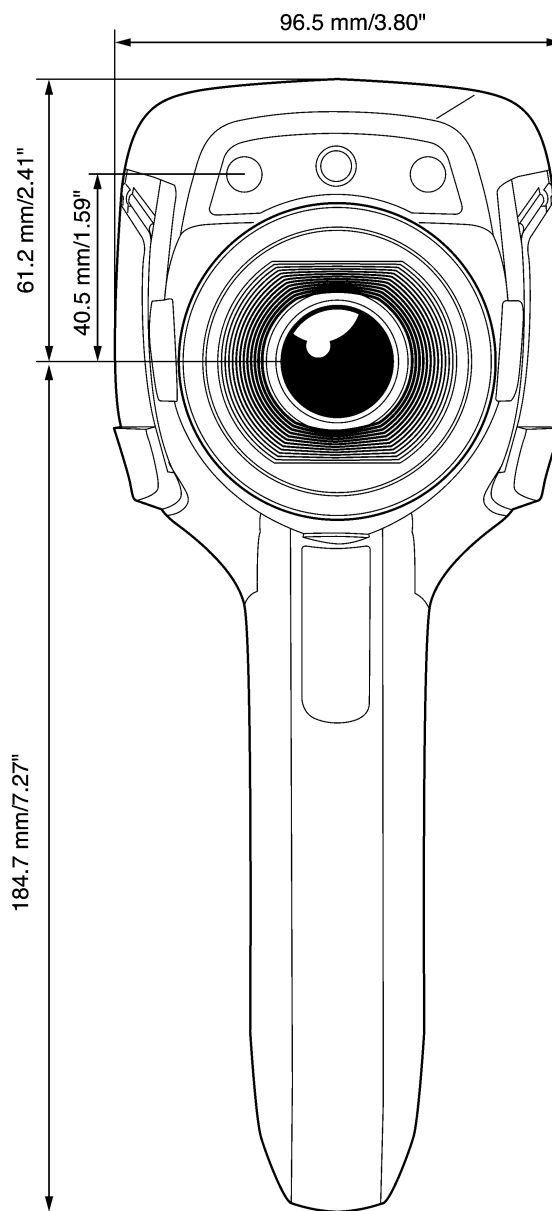

© 2011, FLIR Systems, Inc.  
All rights reserved worldwide.

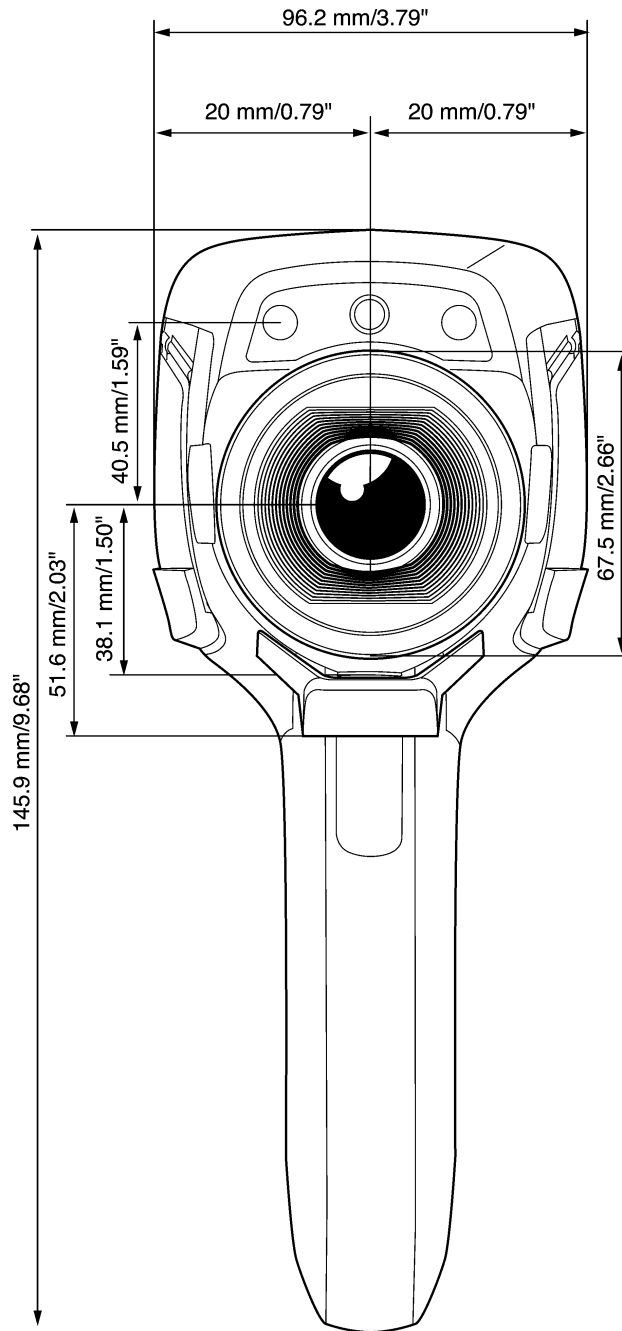

© 2011, FLIR Systems, Inc.  
All rights reserved worldwide.

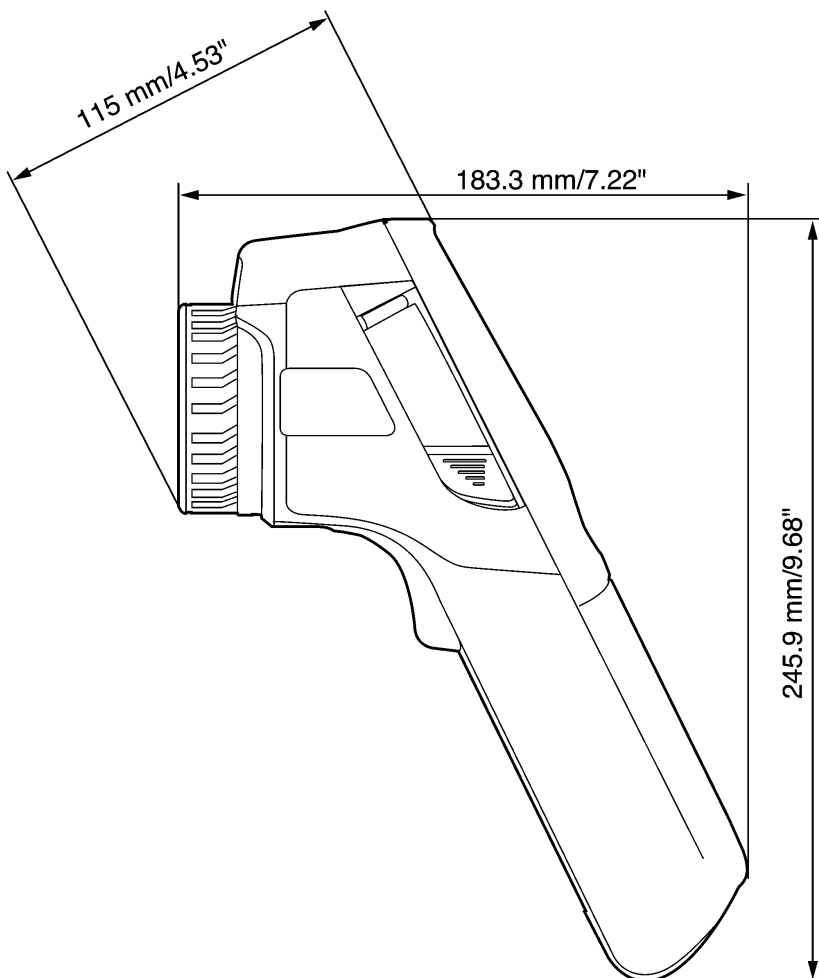

© 2011, FLIR Systems, Inc.  
All rights reserved worldwide.

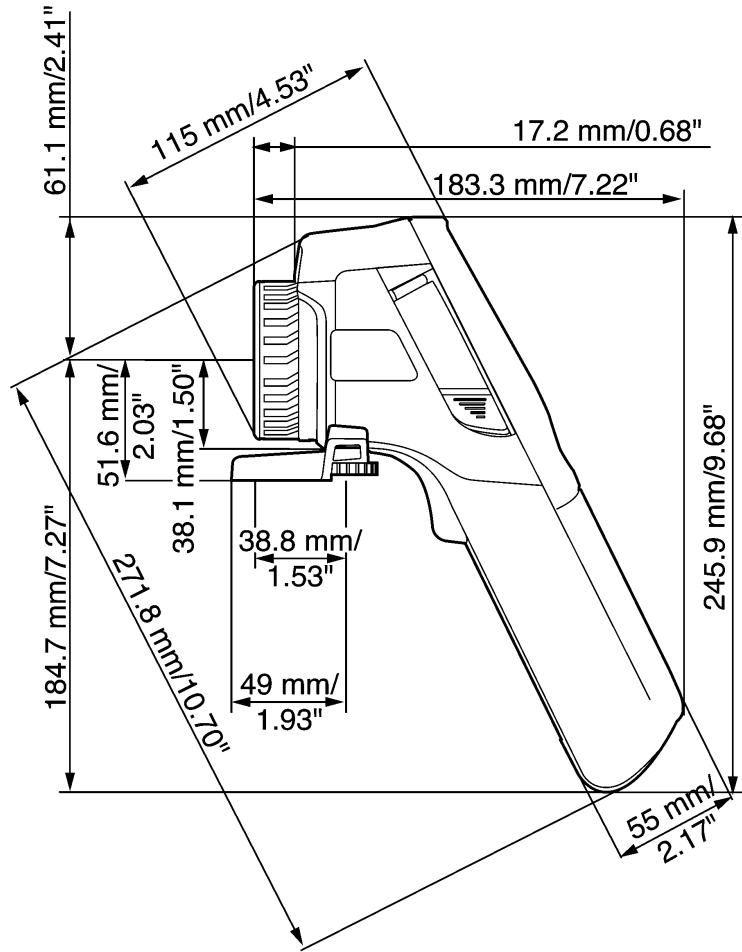

© 2011, FLIR Systems, Inc.  
All rights reserved worldwide.

